

Модерн Модерн R3

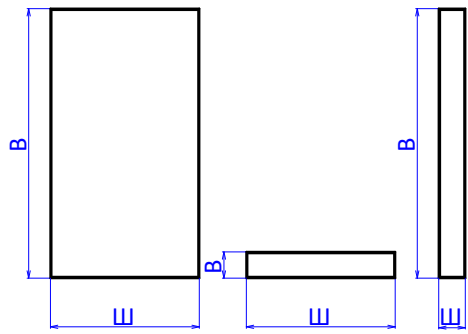

B=296...2500  
Ш=296...1250



B=56...295  
Ш=396...1250

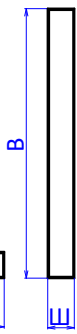

B=396...2500  
Ш=70...295

Прямоугольник

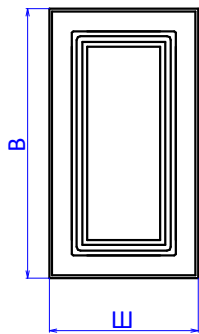

B=296...2500  
Ш=296...1250

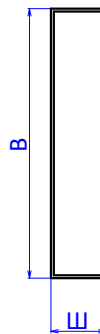

B=396...2500  
Ш=70...174

Прямоугольник ящик

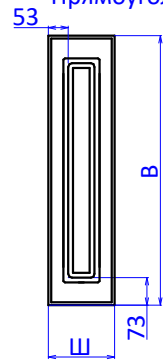

B=396...2500  
Ш=175...295

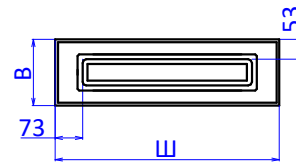

B=175...295  
Ш=396...1250

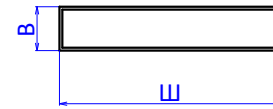

B=56...174  
Ш=396...1250

Кампо



B=250...2500  
Ш=296...349

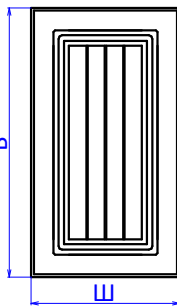

B=250...2500  
Ш=350...450

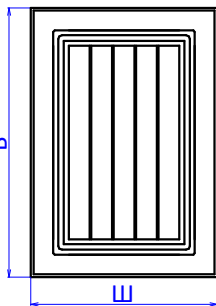

B=250...2500  
Ш=451...550

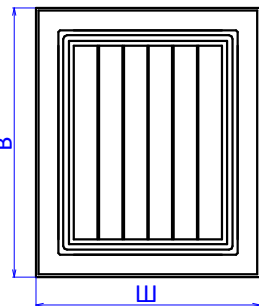

B=250...2500  
Ш=551...650

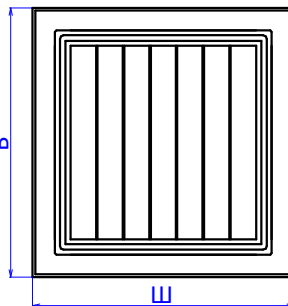

B=250...2500  
Ш=651...750

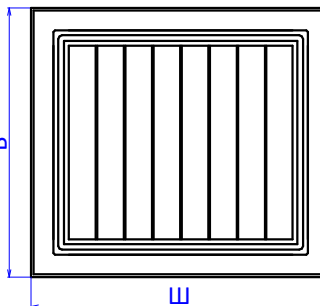

B=250...2500  
Ш=751...850

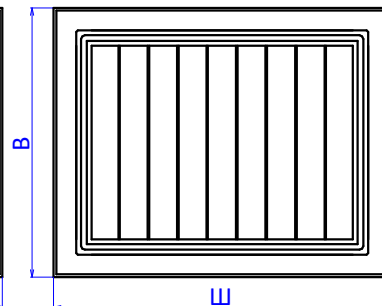

B=250...2500  
Ш=851...950

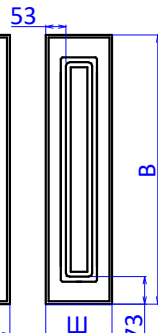

B=250...2500  
Ш=175...295

Кампо ящик

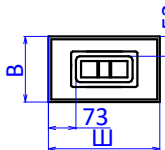

B=175...249  
Ш=296...349

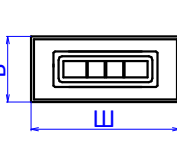

B=175...249  
Ш=350...450

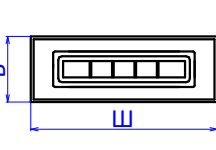

B=175...249  
Ш=451...550

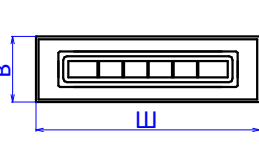

B=175...249  
Ш=551...650

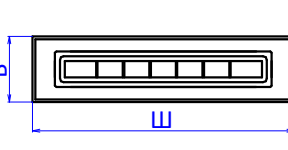

B=175...249  
Ш=651...750

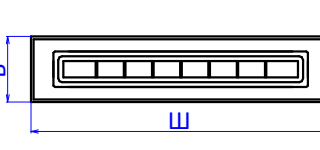

B=175...249  
Ш=751...850

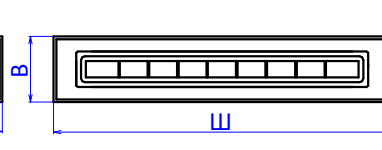

B=175...249  
Ш=851...950



B=56...174  
Ш=295...1250

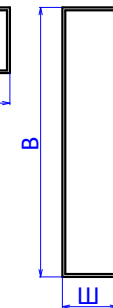

B=250...2500  
Ш=70...174

КВАДРО

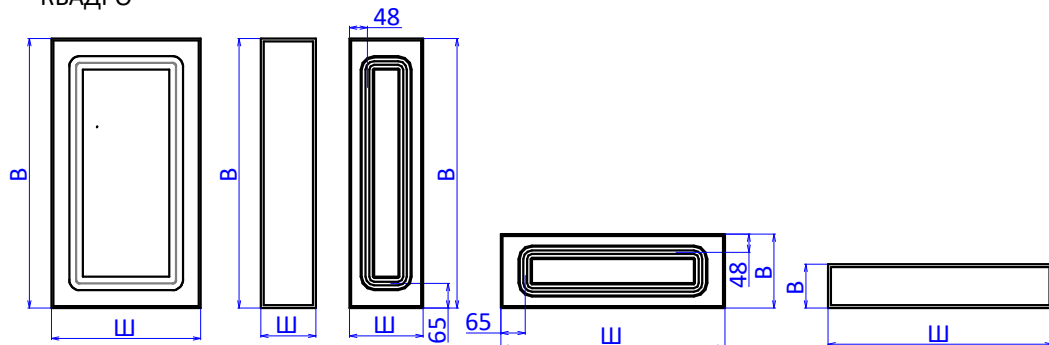

B=296...2500 B=396...2500 B=396...2500 B=175...295 B=56...174  
 Ш=296...1250 Ш=70...174 Ш=175...295 Ш=396...1250 Ш=396...950

РОНДО

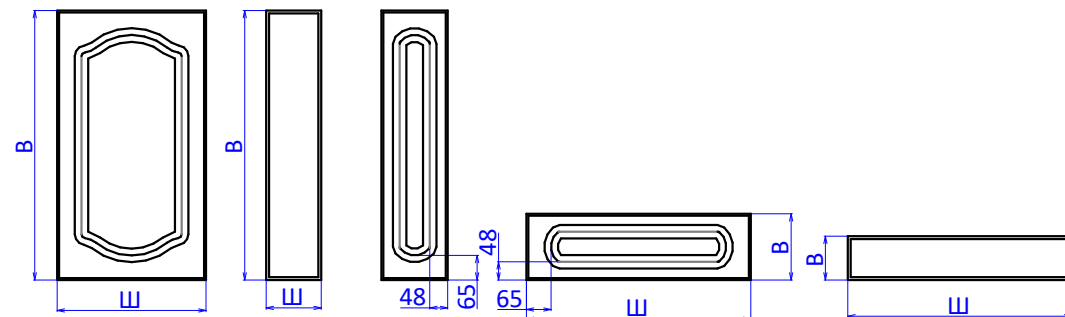

B=296...2500 B=396...2500 B=396...2500 B=175...295 B=56...174  
 Ш=296...1250 Ш=70...174 Ш=175...295 Ш=396...1250 Ш=396...1250

Неаполь

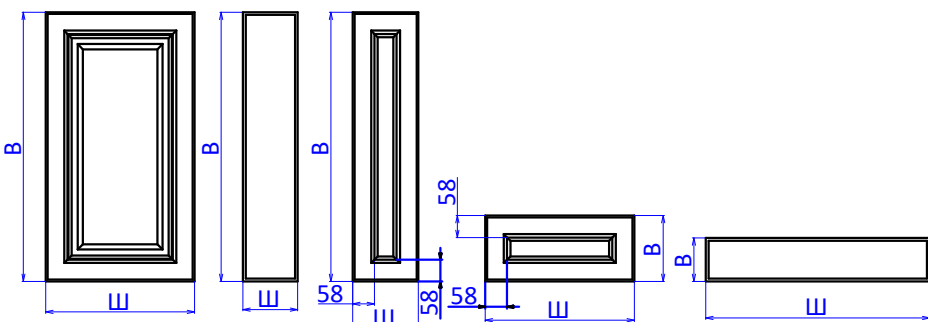

B=296...2500 B=396...2500 B=396...2500 B=175...295 B=56...174  
 Ш=296...1250 Ш=70...174 Ш=175...295 Ш=396...1250 Ш=396...1250

КАПРИЧЧИО

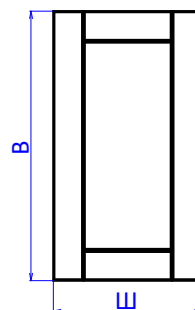

B=457...2500  
 Ш=296...1250

КАПРИЧЧИО R4

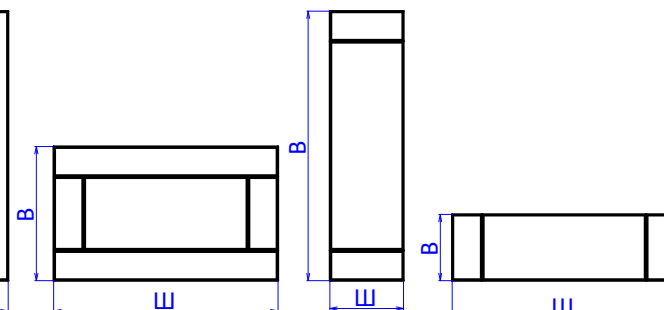

B=296...456 B=396...2500 B=56...295  
 Ш=296...1250 Ш=70...295 Ш=396...1250

Премьера

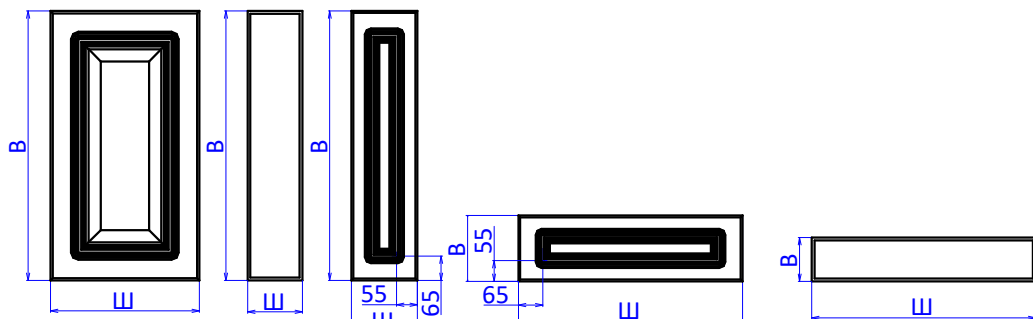

B=296...2500 B=396...2500 B=396...2500 B=176...250 B=56...175  
 Ш=251...1250 Ш=70...175 Ш=176...250 Ш=396...1250 Ш=396...1250

Прямоугольник Фолк

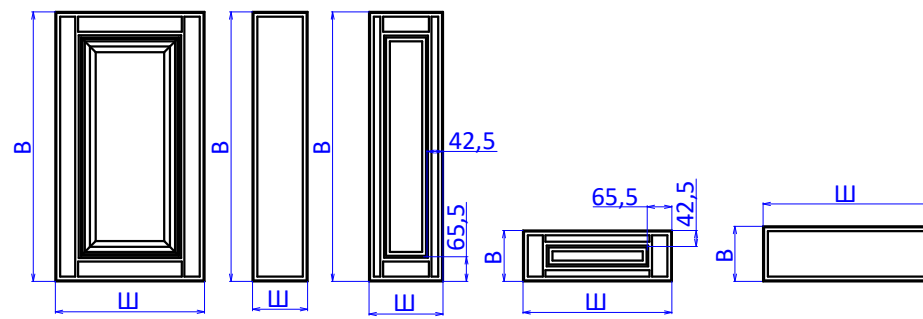

B=296...2500 B=396...2500 B=396...2500 B=135...295 B=56...134  
 Ш=296...1250 Ш=70...174 Ш=175...295 Ш=396...1250 Ш=396...1250

# Фасады "Книжка" с интегрированной ручкой

Фасад "Книжка" 4  
петли ручка слева

Фасад "Книжка"  
без петель ручка  
справа

Фасад "Книжка"  
без петель ручка  
слева

Фасад "Книжка" 4  
петли ручка справа

Интегрированная ручка

Интегрированная ручка R3

Тип 1

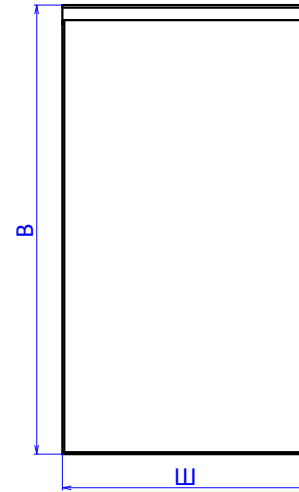
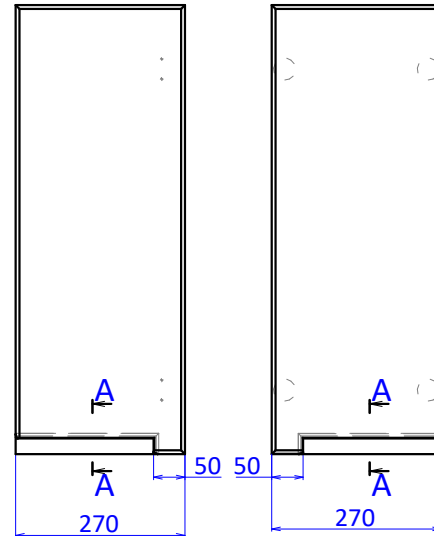
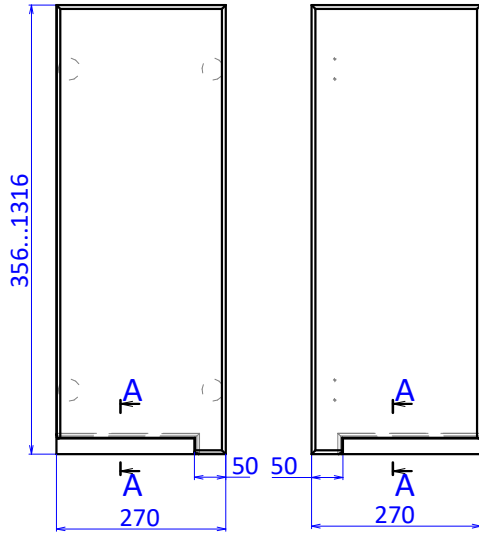

B=396...2500  
Ш=146...1250

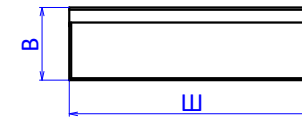

B=116...395  
Ш=396...1250

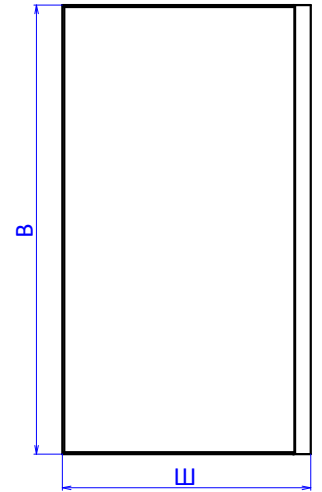

B=500...2500  
Ш=146...1250

Тип 2

Тип 3

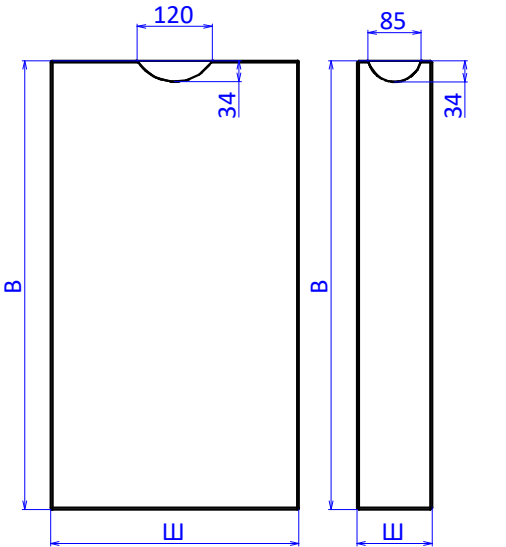

B=116...2500    B=176...2500  
Ш=180...1250    Ш=120...179

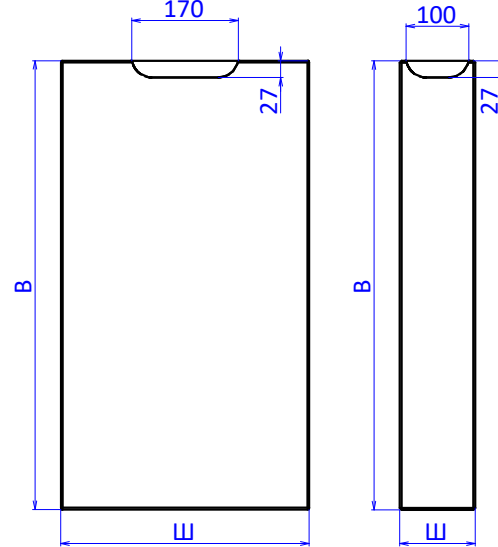

B=116...2500    B=176...2500  
Ш=180...1250    Ш=120...179

Дрезден

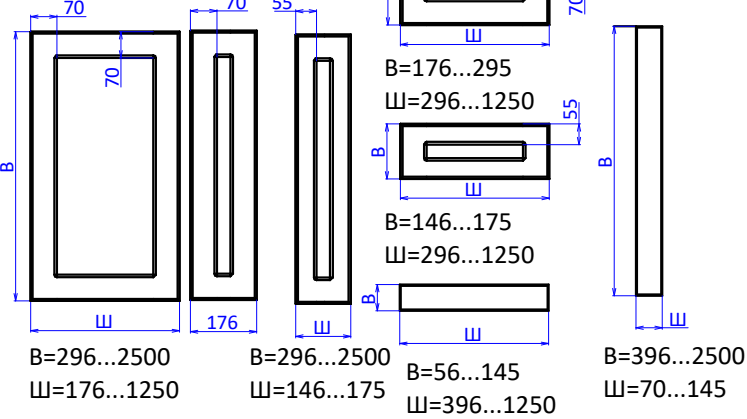

Кельн

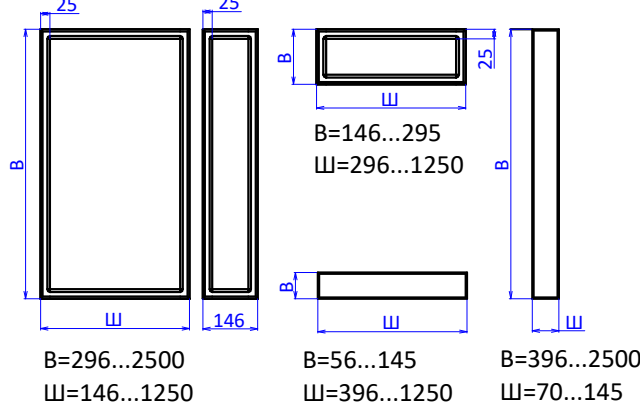

Милан

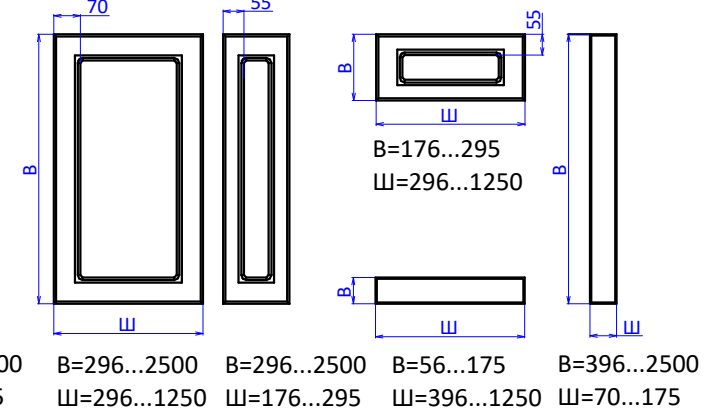

Мюнхен

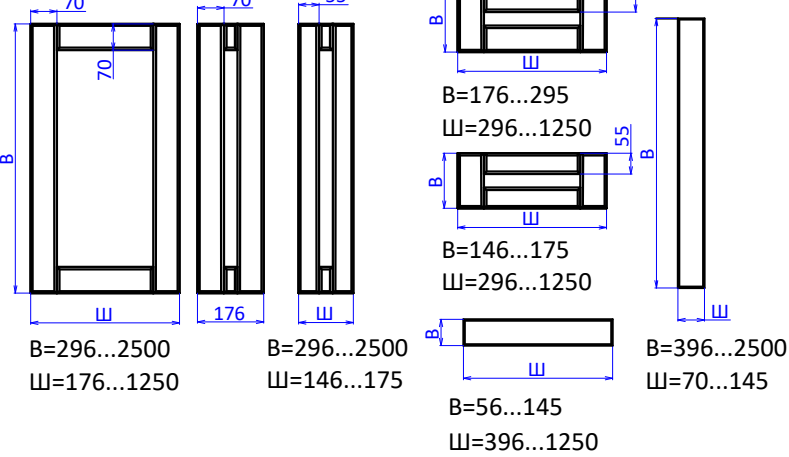

Сатурн

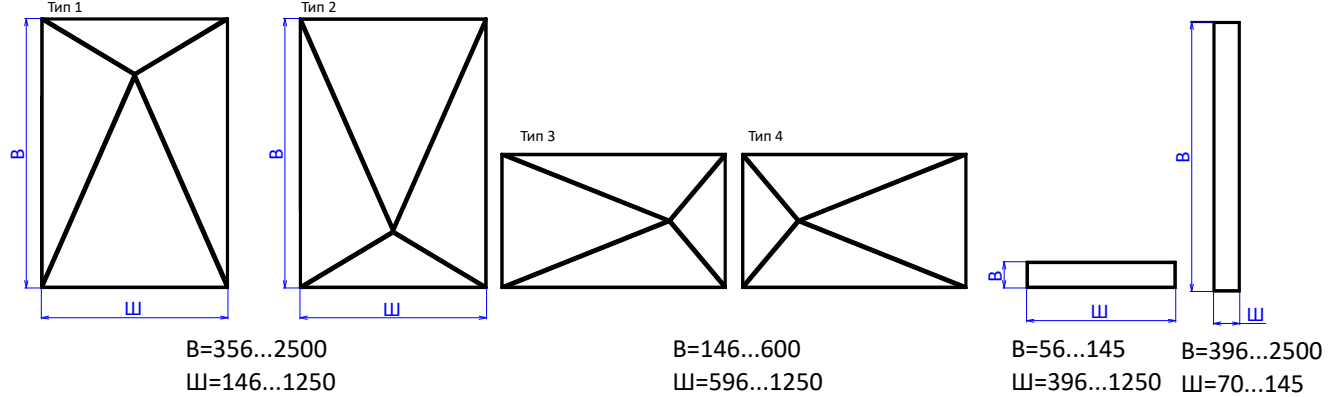

Акцент

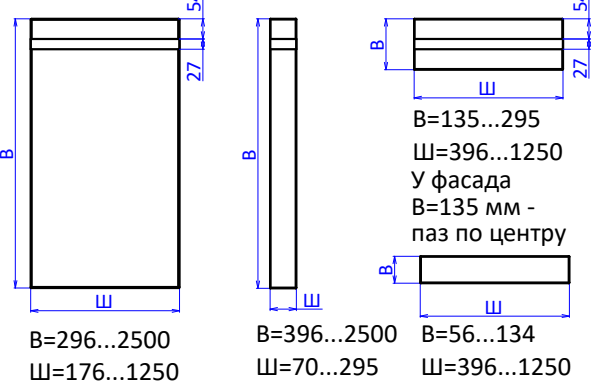

Вертикаль узкая

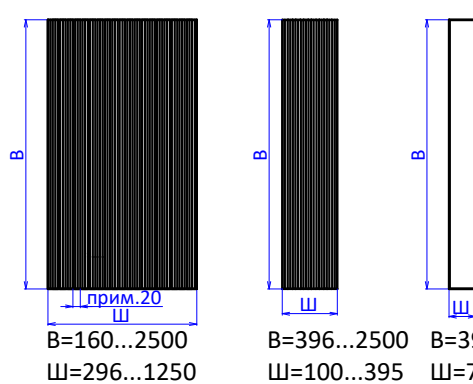

Вертикаль широкая

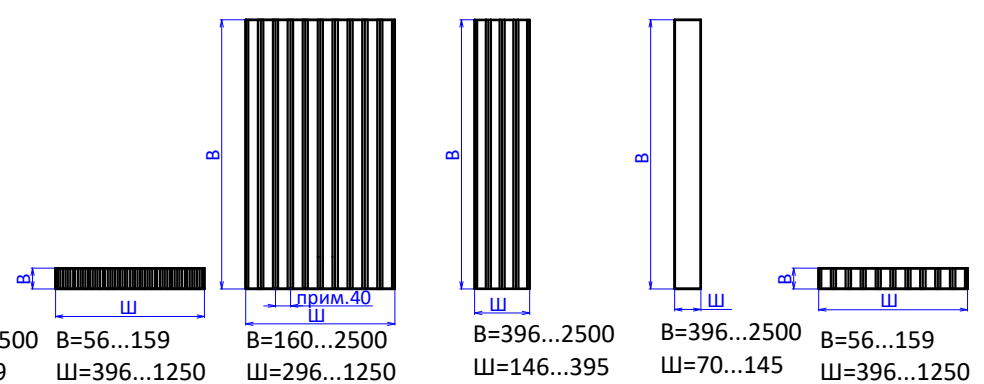

Абстракт

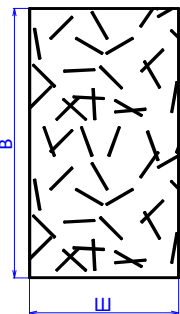

B=160...2500  
Ш=296...1250

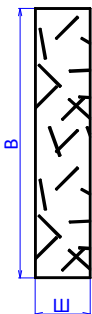

B=396...2500  
Ш=70...295

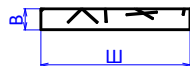

B=56...159  
Ш=396...1250

Бавария

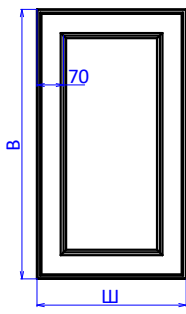

B=296...2500  
Ш=196...1250

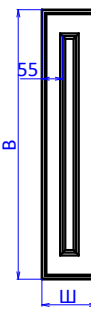

B=396...2500  
Ш=146...195

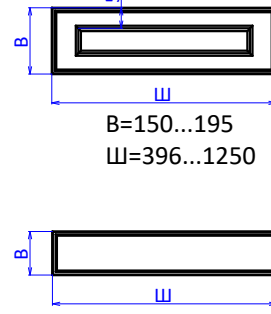

B=150...195  
Ш=396...1250

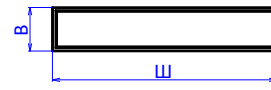

B=56...149  
Ш=396...1250

Вуд Тип 1

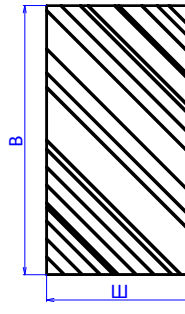

B=160...2500  
Ш=296...1250

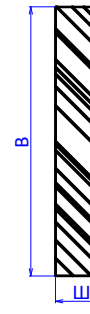

B=396...2500  
Ш=70...295

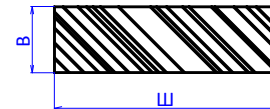

B=56...159  
Ш=396...1250

Вуд Тип 2

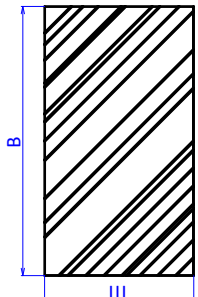

B=160...2500  
Ш=296...1250



B=396...2500  
Ш=70...295

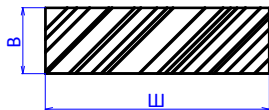

B=56...159  
Ш=396...1250

Бруклин

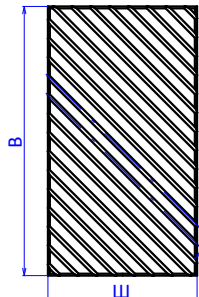

B=160...2500  
Ш=296...1250

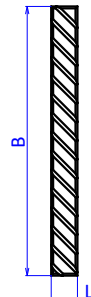

B=396...2500  
Ш=70...295



B=56...159  
Ш=396...1250

Леон

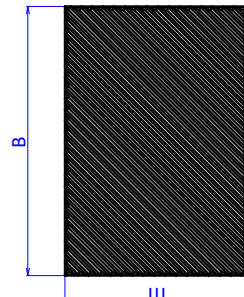

B=160...2500  
Ш=296...1250

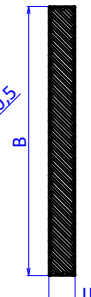

B=396...2500  
Ш=70...295



B=56...159  
Ш=396...1250

Параллель 1

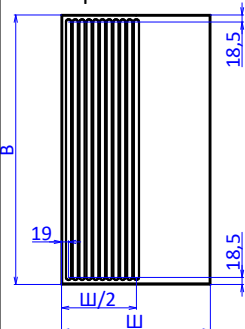

B=160...2500  
Ш=296...1250

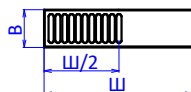

B=100...159  
Ш=396...1250

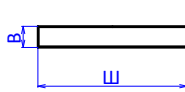

B=56...99  
Ш=396...1250

Параллель 2

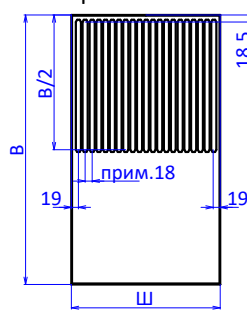

B=322...2500  
Ш=160...1250

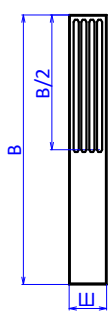

B=396...2500  
Ш=100...159

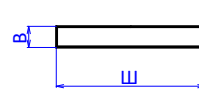

B=56...99  
Ш=396...1250

Параллель 3

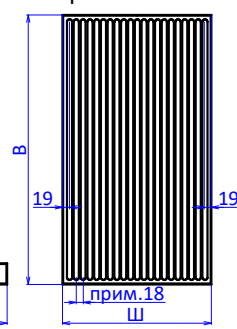

B=160...2500  
Ш=296...1250

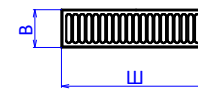

B=100...159  
Ш=396...1250



B=396...2500  
Ш=100...159

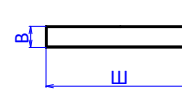

B=56...99  
Ш=396...1250

Флорида

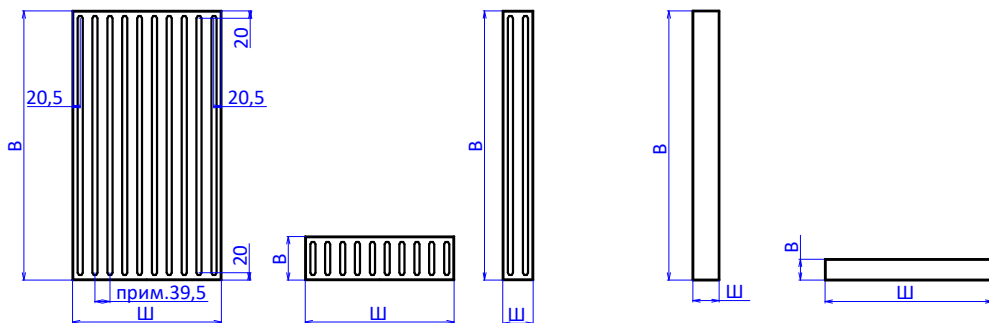

B=160...2500  
Ш=296...1250

B=116...159  
Ш=396...1250

B=396...2500  
Ш=81...295

B=396...2500  
Ш=70...80

B=56...115  
Ш=396...950

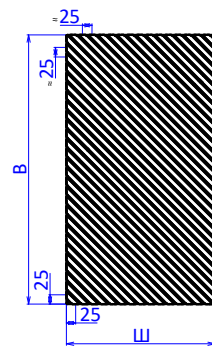

B=160...2500  
Ш=296...1250

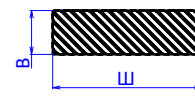

B=56...159  
Ш=396...1250

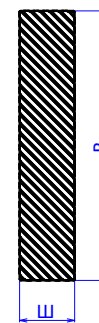

B=396...2500  
Ш=70...295

Даллас

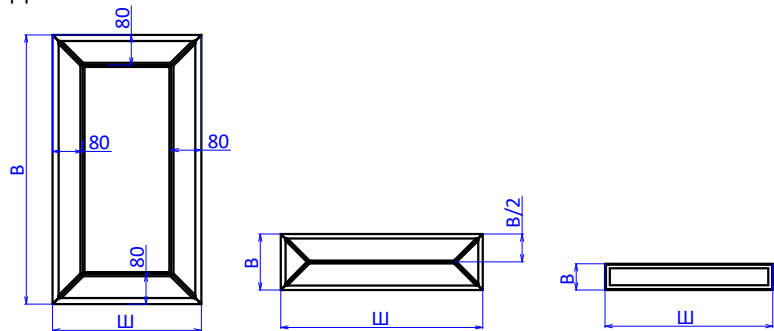

B=200...2500  
Ш=296...1250

B=100...199  
Ш=396...1250

B=56...99  
Ш=396...950

Море

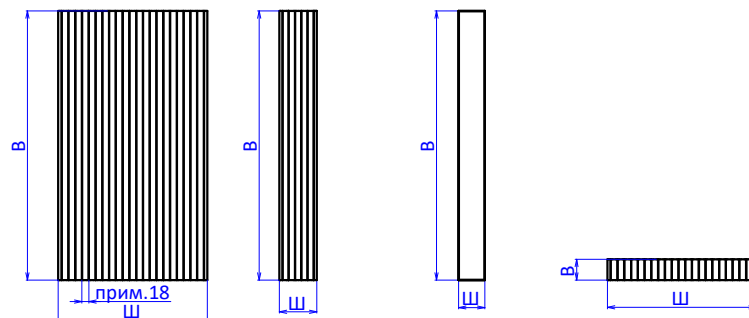

B=160...2500  
Ш=296...1250

B=396...2500  
Ш=100...295

B=396...2500  
Ш=70...99

B=56...159  
Ш=396...1250

Челси

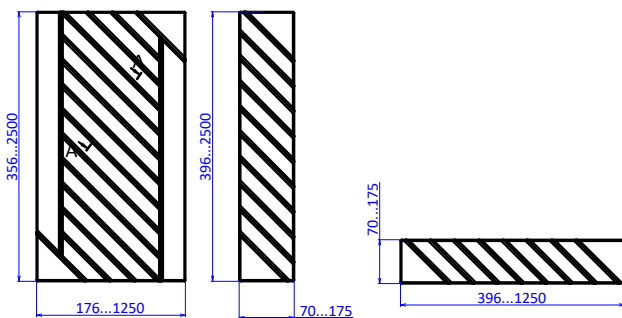

B=176...2500  
Ш=296...1250

B=396...2500  
Ш=70...175

B=70...175  
Ш=396...1250

Ограничения по ширине фасадов (Ш) в зависимости от высоты (В)

